



安装指南

INSTALLATION MANUAL



- 设备 *DEVICE*: **TRAXENS-BOX V2 DRY**
- 产品 *PRODUCT*: **BOX0023**
- 型号 *MODEL*: **2DR-187-000**
- EQUIPEMENT: 集装箱 *CONTAINER*
- 类型 *TYPE*: 干柜/开顶柜 *DRY / OPEN-TOP*



安全须知 V2 DRY (BOX0023) SAFETY NOTES V2 DRY (BOX0023)

下文中“设备”特指 TRAXENS-BOX (BOX0023)

The term "device" is used in this document to mean TRAXENS-BOX (BOX0023).

- 设备必须由获资质的设备安装人员操作，此人必须负责并遵守相关操作规定，标准和流程
Device must be installed by a qualified technician who is responsible for compliance with regulations, standards, and guidelines.
- 操作前请务必仔细阅读此说明书并严格按照步骤操作
Read installation manual before handling device and follow every installation step.
- 安装前请确认操作环境安全
Before installation, make sure that installation site is safe.
- 如需在高空作业，请遵高空作业的规定
In case of work aloft, follow safety measures to work at heights.
- 使用合适的个人防护用品
Use appropriate PPE (Personal Protective Equipment).
- 遵循当地垃圾污物处理规定
Follow local electronic waste disposal regulations.
- 将设备存放于安全的地方
Store device in a safe place.
- 不要试图打开 或拆解设备
Do not try to open or dismantle device.
- 不要对设备施加 过度的压力
Do not apply excessive pressure to device.
- 不要移除设备背后的磁铁
Do not remove the anti-tearing magnet on the backside of the device.
- 设备中含有锂电池。电池 100 摄氏度以上会爆炸并引起火灾
Device contains Lithium batteries. Exposure of Lithium to a temperature above 100 °C can lead to fire.
- 电池为不可更换电池。如更换不合适的电池，将有爆炸风险
Batteries are not replaceable. There is a risk of explosion if batteries are replaced by an inappropriate battery type.
- 根据指示处理用过的电池。根据当地法规，电池应该回收利用
Dispose of used batteries according to instructions. Battery should be recycled according to the local legislation.
- 不要将设备暴露在碳氢化合物或化学产品中
Do not expose device to hydrocarbon or chemical products.
- 请用淡肥皂水清洗设备
Clean device with slightly soapy water.
- 如果设备不能正常工作或摔落，请不要使用
Do not use device if it does not function properly or if it has fallen.
- 使用过的电池不能随意丢弃。不允许燃烧或直接扔进垃圾桶
The used battery could not be discarded freely. It is not allowed to burn or throw directly into the trash can.
- 严禁在允许温度范围外使用或加热
Strictly prohibited to use or heat outside the permitted temperature range.
- 建议将设备存储在 25°C (77°F) 区域
It is recommended to store the devices in a 25°C (77°F) area.

警告：FCC 和 ISED 射频暴露声明

此设备产生并辐射射频能量。为了符合 FCC 和 ISED 射频辐射暴露指南的非受控环境，该设备必须安装和操作系统，同时保持人体到天线的最小距离为 20cm。不允许用户以任何方式更改或修改系统

WARNING FCC and ISED Radio-frequency Exposure Statement

This equipment generates and radiates radio-frequency energy. In order to comply with the FCC and ISED radio-frequency radiation exposure guidelines for uncontrolled environment, this equipment has to be installed and operated while maintaining a minimum body to antenna distance of 20cm. Users are not permitted to make changes or modify the system in any way.

技术参数 V2 DRY (BOX0023)

TECHNICAL INFORMATION V2 DRY (BOX0023)

•运行温度范围: -40°F to 185°F / -40°C to 85°C

Operating temperature range: -40°F to 185°F / -40°C to 85°C

TRAXENS 提供的设备 *Packing content provided by TRAXENS*

每一次安装, TRAXENS 会提供: *TRAXENS provides for one installation:*

- 1 台设备 TRAXENS-Box DR-187-000 *1 TRAXENS-Box DR-187-000*
- 4 个铆钉 *4 blind rivets*

第一次发货, TRAXENS 会提供: *The first shipment TRAXENS provides:*

- 1 个钻孔模具- EIP0047 *1 drilling template - EIP0047 #1*

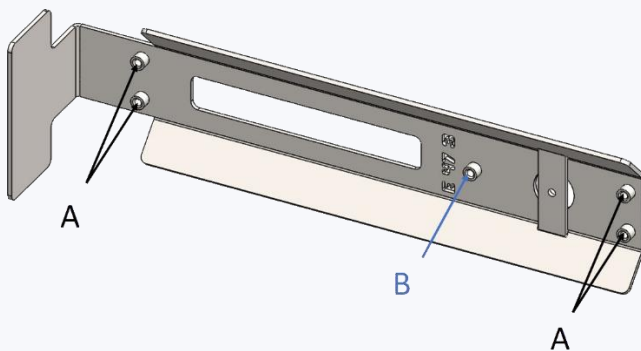

注意: 钻孔描述:

Note: drill bushes description

A: 钻铆钉

A: for blind rivets

B: 感光传感器

B: for ambient light sensor

#1

安装操作者需要 *The installer will need:*

- 手电钻 *Electric hand drill*
- Ø 5 mm 钻头 *Ø 5 mm drill bits*
- 钳子或扳手 *Jaw wrench or crew clamp*
- 密封胶 *Silicone mastic*
- 手动铆枪 *Manual punch riveter*

第一步：提前激活 *STEP 1: early wake-up*

TRAXENS 要求在设备安装前 1 小时，提前将设备激活确保 GSM 信号正常。实际操作中，堆场可以提前激活所有当日需要安装的设备

注意：请激活当日计划安装的设备

TRAXENS requires device one-hour early wake-up phase to ensure initial GSM communication before physical installation on the equipment. In practice, a depot might wake up at the same time all devices to meet daily installation requests.

CAUTION: wake up devices that are planned to be installed during the day.

<p>0</p>	<p>操作者将会需要 TRAXENS Field App 以完成安装 <i>Installer will need TRAXENS Field App to proceed with the installation.</i></p> <p>见使用手册 See user guide</p>
<p>1</p>	<p>取出设备和配件并放在特定的桌面上（见右图） 根据下一个步骤“如何激活设备”中的说明，激活所有设备</p> <p><i>Sort out devices and accessories on a dedicated table (see picture above). Wake-up all devices following next procedure "How to wake-up TRAXENS-BOX".</i></p> <div data-bbox="826 651 1428 1021" data-label="Diagram"> </div> <p style="text-align: right;">激活操作台设计建议 <i>Wake-up area design recommendations</i></p>
<p>2</p>	<p style="text-align: center;">检测信号 <i>Communication test</i></p> <p>点击“Health Check”扫描每一个设备，检查 GSM 信号正常。 <i>Flash each device using the "Health Check" functionality to verify GSM communications are OK:</i></p> <ul style="list-style-type: none"> • 点击“Health Check” <i>Select "Health Check" functionality</i> • 输入设备 SN，手动或扫描二维码皆可 <i>Enter device serial number, either manually or by scanning the QR code</i> <p>参考视频 如何检测设备激活状态' See video "How to check device wake-up status"</p> <div data-bbox="1177 1256 1374 1451" data-label="Image"> </div>

<p>3</p>		<p>首先检查左侧 LED 是否闪绿色 <i>In the first place check if left led on device is flashing green</i></p> <p>如果闪蓝色，请重新进行激活动作 <i>If flashing blue retry device wake up procedure</i></p>	
		 <p>图标为红色 <i>Icon is red</i> 设备没有连接 <i>Device does not communicate.</i></p> <p>不要安装设备 <i>Do not install the TRAXENS-Box on the equipment</i></p>	 <p>图标为绿色 <i>Icon is green</i> 设备连接正常 <i>Device communicates.</i></p> <p>可以安装设备 <i>Install the TRAXENS-Box on the equipment.</i></p>
<p>如果设备 24h 以后还没有连接，请联系客服 support1@traxens.com，我们会指导您如何操作</p> <p><i>If device is not communicating after 24 hours, contact support1@traxens.com who will suggest you how to proceed</i></p>			

如何激活设备 *How to wake-up TRAXENS-BOX*

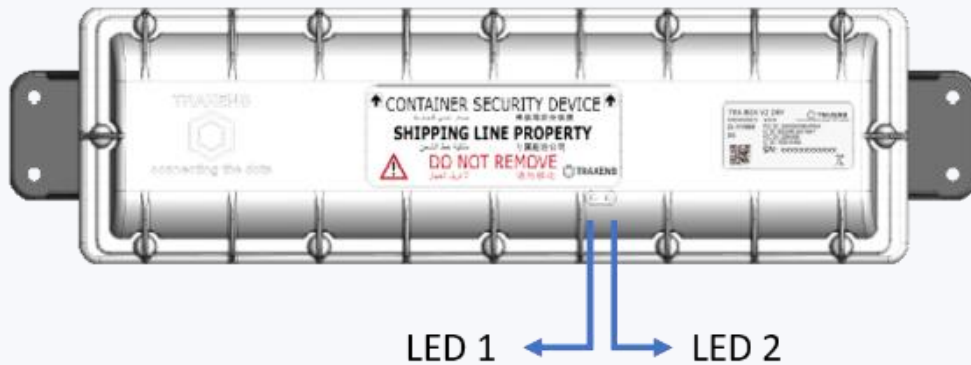



图一：TRAXENS-BOX V2 DRY LED 灯图示 *Figure 1: TRAXENS-BOX V2 DRY LEDs identifications*

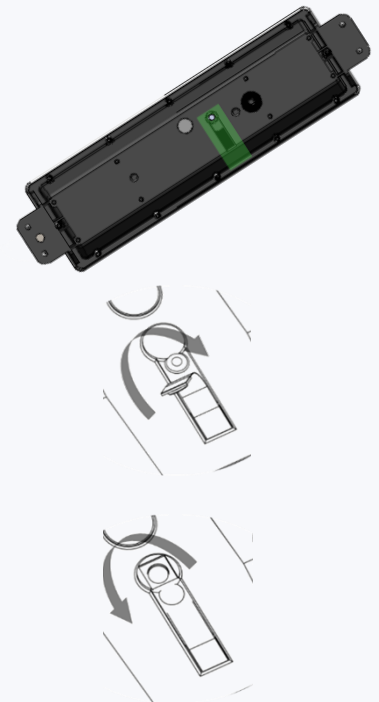



- A. **请先确认 LED2 每 15 秒闪一下蓝色灯 (睡眠模式)** *Ensure that LED 2 is flashing blue every 15 seconds (sleep mode)*
- B. **取下背面磁铁保护胶带** *Remove the anti-tearing adhesive protection*
- C. **向身体方向移动磁铁, 并保持静止** *Move the magnet away and hold it on*
 - 待到 LED2 闪 4 次蓝灯然后持续 2 秒 *LED 2 is flashing blue 4 times then is flashing steady 2 seconds*
 - 在 2 秒结束前*, 进行 D 步骤 *Before the 2 seconds end *, go to point D*
- D. **将磁铁归位, 并保持静止** *Move the magnet back and hold it on*
 - 待到 LED2 闪四次白灯然后持续 2 秒 *LED 2 is flashing white 4 times then is flashing steady 2 seconds*
 - 在 2 秒结束前*, 进行 E 步骤。 *Before the 2 seconds end *, go to point E*
- E. **向身体方向移动磁铁, 并保持静止** *Move the magnet away and hold it on*
 - 待到 LED2 闪 4 次绿灯然后持续 2 秒 *LED 2 is flashing green 4 times then is flashing steady 2 seconds*
 - 在 2 秒结束前*, 进行 F 步骤 *Before the 2 seconds end *, go to point F*
- F. **将磁铁归位, 并放手** *Move the magnet back and release it*
 - LED2 每 15 秒闪一次绿灯 *LED 2 is flashing green every 15 seconds*
- G. **设备激活成功** *Device is awake*

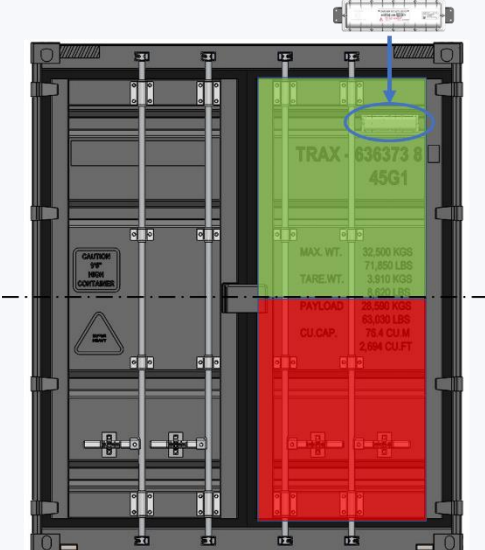

(*如果没有遵守时间节点, 激活序列将会重新开始 *If timeline is not respected, sequence will start over*)

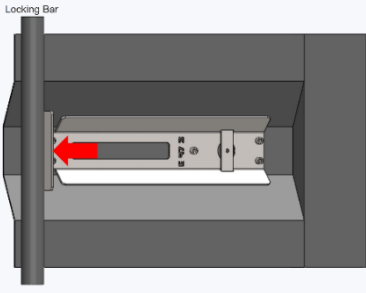
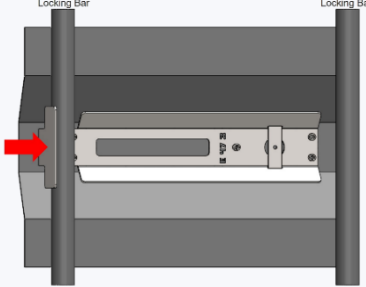
第二部：设备安装 *STEP 2 : TRAXENS-BOX INSTALLATION*

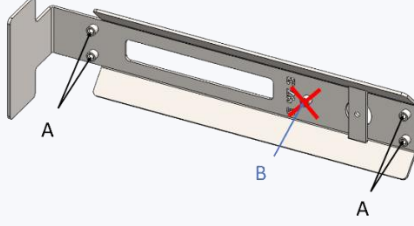
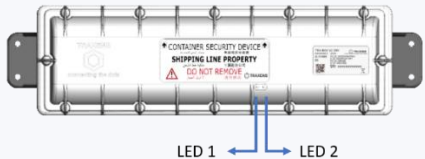
<p>1</p>	<p><u>设备位置</u> <i>Device location</i></p> <ul style="list-style-type: none"> • 右门 <i>Right door</i> • 绿色区域 <i>Green area</i> • 最高处的凹槽内 <i>Inside highest container corrugation</i> • 表面无标记 <i>Free of markings</i> <p>不要将设备安装在红色区域 <i>Never install device inside red area</i></p>	
<p>注意 <i>Note</i></p>	<p>如果没有无标记的凹槽，请将设备固定在：<i>If there is a lack of door corrugation without markings, device should be secured:</i></p> <ul style="list-style-type: none"> • 凹槽外侧 <i>Outside door corrugation</i> • 平行 <i>Horizontally</i> • 尽量靠近凹槽上侧 <i>As close as possible to the upper metal fold</i> 	

设备固定 <i>Device securing:</i> 使用钻孔模具#1来固定设备安装位置 <i>Use the drilling template #1 to position precisely the device</i>		
设备位置 <i>Device location</i>	门杆右侧 (优先) <i>Locking bars right side (preferred)</i>	两个门杆中间 <i>Between locking bars</i>
钻孔模具位置 <i>Drilling template location</i>		
2	<p>将钻孔模具夹在右门杆的右侧 钻孔模具平放在凹槽内 使用钳子将模具牢固地固定在门杆上 使用 Ø 5 mm 钻头定位 5 个孔位 <i>Clamp the drilling template against the right locking bar right side.</i> <i>The drilling template is positioned flat in the corrugation hollow.</i> <i>Secure drilling template firmly with a jaw wrench on the locking bar.</i> <i>Point 5 holes with Ø 5 mm drill bit.</i></p>	<p>将钻孔模具夹在右门杆的右侧 钻孔模具平放在凹槽内 使用钳子将模具牢固地固定在门杆上 使用 Ø 5 mm 钻头定位 5 个孔位 <i>Clamp the drilling template against the left locking bar left side.</i> <i>The drilling template is positioned flat in the corrugation hollow.</i> <i>Secure drilling template firmly with a jaw wrench on the locking bar.</i> <i>Point 5 holes with Ø 5 mm drill bit.</i></p>
注意 <i>Note</i>	 <p>如果是开顶的集装箱, 请不要打 B 孔 <i>In case of open top containers, do not drill light sensor hole B.</i></p>	
3	<p>定位好后, 移走模具, 使用 Ø 5 mm 钻头完成钻孔 <i>After pointing, remove drilling template and complete drilling with Ø 5 mm drill bit.</i></p> <p>不要使用切割油 <i>Do not use cutting oil.</i></p>	
4	<p>固定前确认设备已被激活 <i>Make sure device is awake before securing it.</i></p>	 <p>LED 1 LED 2</p> <p>LED 2 blinking green every 5 seconds</p>
5	<p>用 2 个铆钉固定设备 <i>Secure device with 4 provided rivets.</i></p>	
		

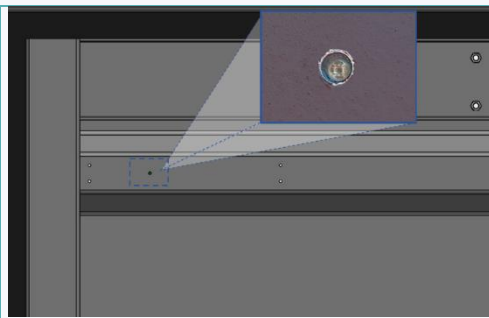
<p>6</p>	<p>确认感光孔 B 在设备感光传感器的中央 <i>Make sure the ambient light sensor hole B is centered with the sensor.</i></p>	
<p>7</p>	<p>从门内侧使用密封胶 <i>Apply polyurethane mastic on the rivets and seal support from the door inside.</i> 不要遮住感光孔 B! Do not fill up the ambient light sensor hole B.</p>	

第三步：配对设备和集装箱 *STEP 3: pairing TRAXENS-BOX and container*

为了匹配设备 ID 和集装箱 ID，安装者需要使用 TRAXENS 手机程序对设备进行配对。

To associate container ID and TRAXENS-BOX ID, the installer needs to pair them with TRAXENS mobile application.



该 APP 可以在 Google Play 商店中下载。输入关键词“TRAXENS”，并下载“Field”APP

This application is available on Google Play Store. Search for the keyword “TRAXENS” and download the application named “Field”.



您也可以扫描右侧二维码下载。*You can also flash this QR code to get a direct link to the application.*

观看演示视频‘[如何配对设备并完成首次集装箱放行](#)’

See video “[How to pair device and proceed to first equipment release](#)”

请联系 TRAXENS 团队收取您的账号: support1@traxens.com

Please contact TRAXENS team to receive your login: support1@traxens.com

手机程序操作手册如下 *The mobile application instruction manual is available at*

<https://upload.traxens.com/index.php/s/RgSI5pqwb9eiwYg>

安装视频 **INSTALLATION VIDEO**



点击下方链接，了解安装步骤

This video is a quick and easy way to discover the installation procedure:

<https://vimeo.com/438881253/466e5ea056>

或，扫描左方二维码，获得视频链接 *Flash this QR code to get a direct link to the video.*

为了符合 TRAXENS 安装要求，请仅参考本手册中包含的 TRAXENS 书面建议

Please refer only to TRAXENS written recommendations contained in this manual to comply with TRAXENS installation requirements.